

ELECTRICAL PROPERTIES

Critical Impulse Flashover Voltage		
Positive	kV	105
Impulse Withstand Voltage	kV	95
Wet p.f. Withstand Voltage	kV	30

PHYSICAL PROPERTIES

Nominal Creepage Distance	In.	14
Net Weight	lb.	7.9
Color		Light Grey

MECHANICAL PROPERTIES

Cantilever Strength, Upright	lb.	1200
Cantilever Strength, Underhung	lb.	1200
Torsion Strength	in. - lb.	5000
Tension Strength	lb.	5000
Reference Standard		ANSI C29.9

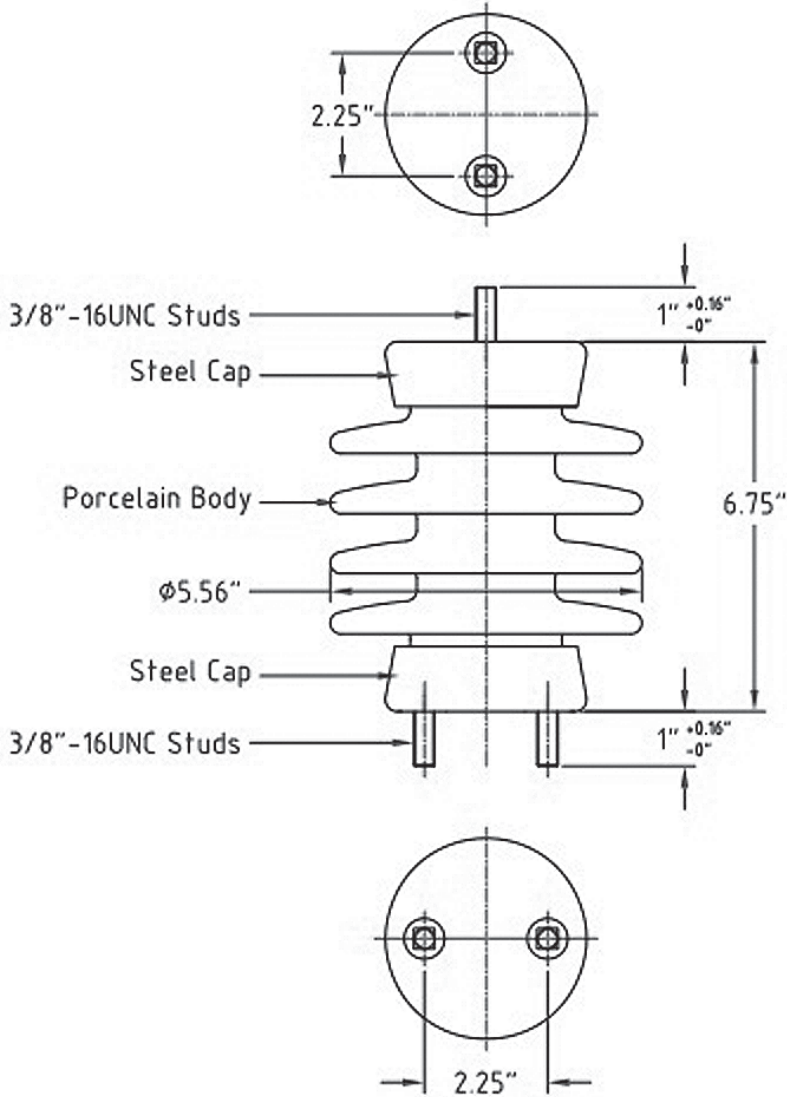

NOTES:

1. All ferrous parts Hot Dip Galvanized.
2. Exposed cement surface coated with silicone.



Medium Voltage Solutions

Erie, Pennsylvania, USA
Tel: 814-520-6385
Email: info@mvpower.us
Web: www.mvpower.us

PART NO. 6038AX
PORCELAIN SWITCH POST INSULATOR
15kV, 95kV BIL